



With or without terminals



DK 0202 G

- 0.75-2.5 mm², Cu 3~







- terminal with 2 clamping units per pole
- 5-pole per pole 8 x 0,75-1 mm² r / f, 6 x 1,5 mm² r / f, 4 x 2,5 mm² r / f, 2 x 4 mm² r / f
- with integrated elastic membranes, which can be removed for cable entry via cable glands, sealing range 6.0-15.0 mm
- with one cable entry in the bottom, sealing range Ø 6.0-13.0 mm
- lid fasteners sealable without accessories
- retaining strap and external brackets for wall fixing included
- colour: grey, RAL 7035
- To close opened membranes use grommets type EDK. Degree of protection = IP 66.

rated insulation voltage	U _i = 690 V a.c./d.c.
rated current:	20 A
material	PP (polypropylene)
degree of protection	IP 66
width	93 mm
height	93 mm
depth	62 mm
weight	0,129 kg
tightening torque for terminal	0.5 Nm
in accordance with	IEC 60670-22

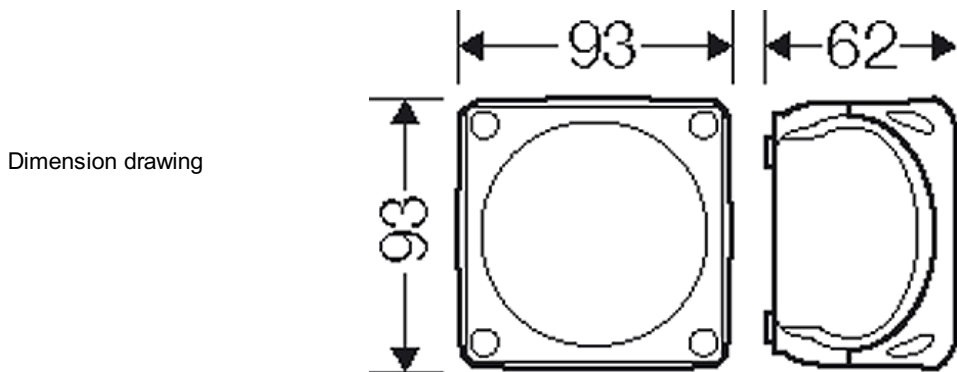
Drawings



With or without terminals



DK 0202 G

- 0.75-2.5 mm², Cu 3~

IP
66



Detail mass

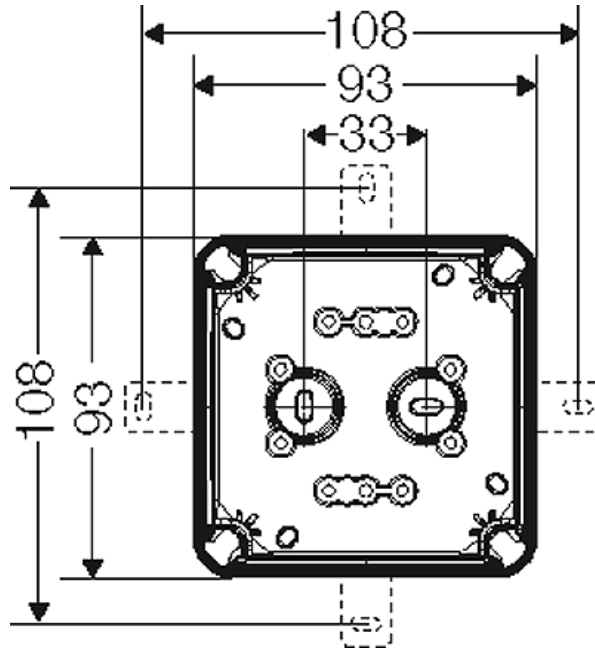

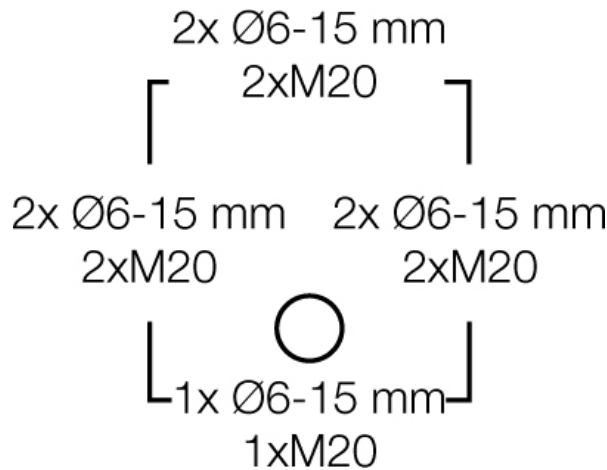

Box walls



Operating and ambient conditions

Application area	Suitable for indoor installation and outdoor installation, protected against weather influences
Ambient temperature	Average value over 24 hours + 35 °C Maximum value + 40 °C Minimum value - 25 °C
Relative humidity	50% at 40° C short-time 100% at 25° C
Fire protection in the event of internal faults	Demands placed on electrical devices from standards and laws Minimum requirements - Glow wire test in accordance with IEC 60695-2-11: - 650°C for boxes and cable glands - 850°C for parts of insulating material necessary to retain current carrying parts in position

With or without terminals

	<p>DK 0202 G</p> <ul style="list-style-type: none"> • 0.75-2.5 mm², Cu 3~ 	
		

<p>Burning behaviour</p>	<p>Glow wire test IEC 60695-2-11: 750 °C UL Subject 94: V-2 flame-retardant self-extinguishing</p>
<p>Degree of protection against mechanical load</p>	<p>IK07 (2 Joule)</p>
<p>Toxic behaviour</p>	<p>halogen-free silicone-free "halogen-free" in accordance with the examination of the cables and insulated wires - corrosiveness of fumes - as per IEC 60754-2</p>
<p>Note:</p>	<p>For material properties see technical data.</p>